

Tube Coolers for Small Signal Tubes. Sizes, Fitted Tubes, Cooling Specs & Minimum Glass-to-Glass Spacing.

MCF-7: 7-pin Miniature Cooling Performance

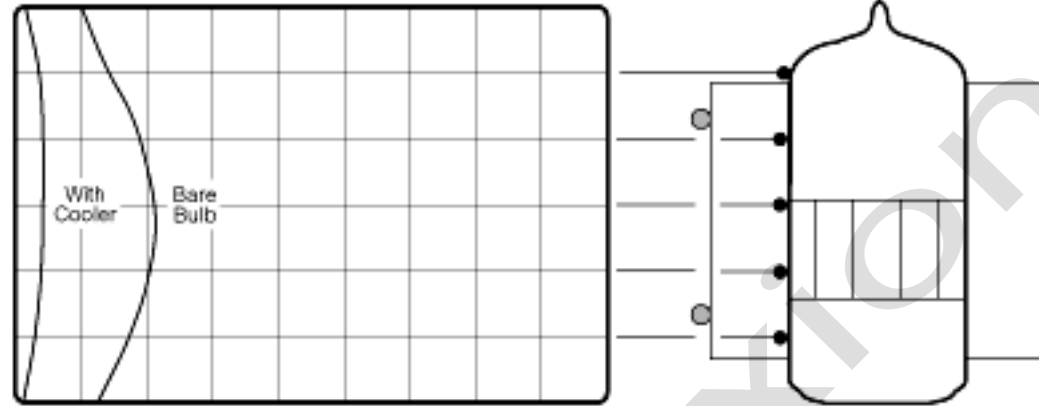

50 75 100 125 150 175 200 225 250 275° C
122 167 212 257 302 347 392 437 482 527° F

Tube Types for this
Cooler Model: 6AU6, 6136, 6J6, 6X4

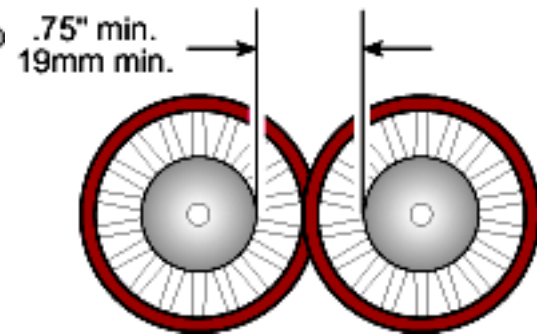
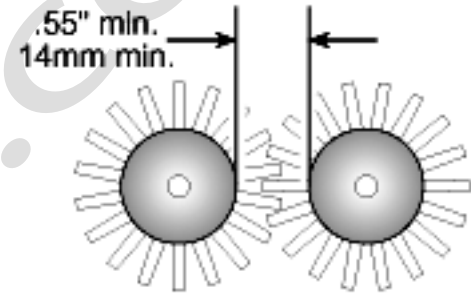

MPCF-7: 7-pin Miniature Power Cooling Performance

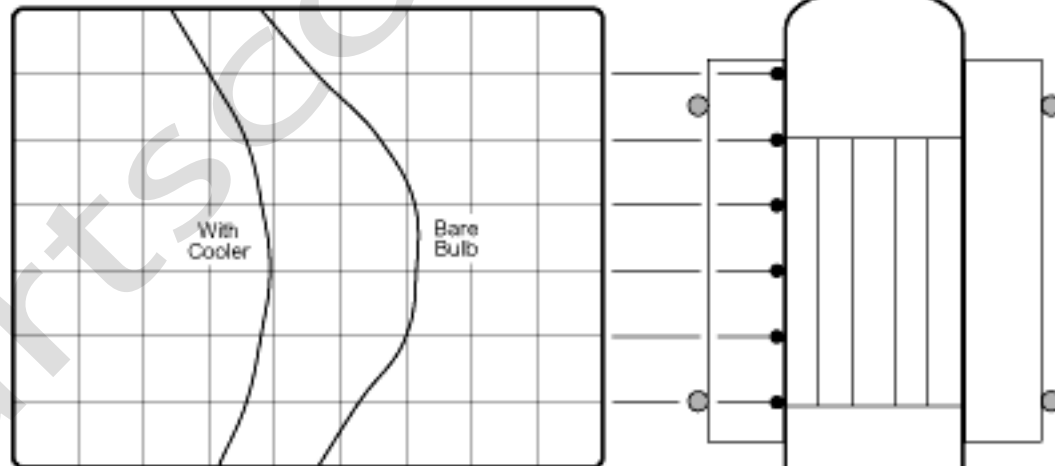

50 75 100 125 150 175 200 225 250 275° C
122 167 212 257 302 347 392 437 482 527° F

Tube Types for this
Cooler Model: 6AQ5, 6005, 6094, 6095, EL90, M8245

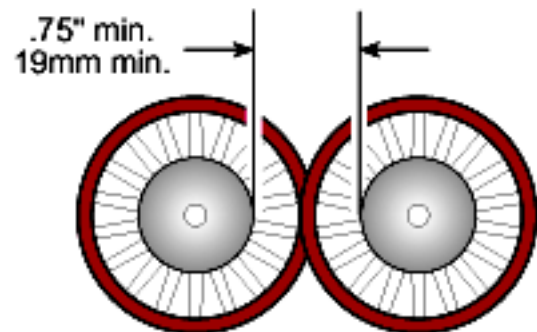
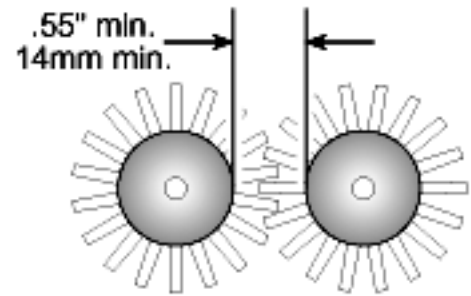



Tube Coolers for Small Signal Tubes. Sizes, Fitted Tubes, Cooling Specs & Minimum Glass-to-Glass Spacing.



OCF-8

Tube Types for this Cooler Model: 6SN7, 5692, 6SL7, 5691, 6BL7, 6BX7, 6X5

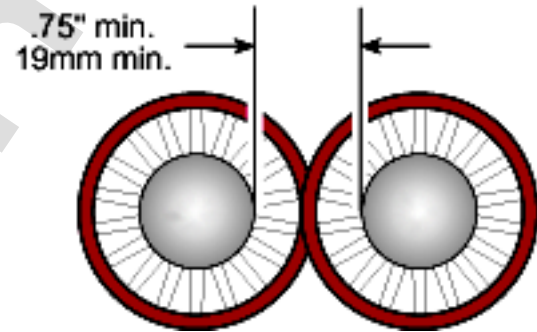
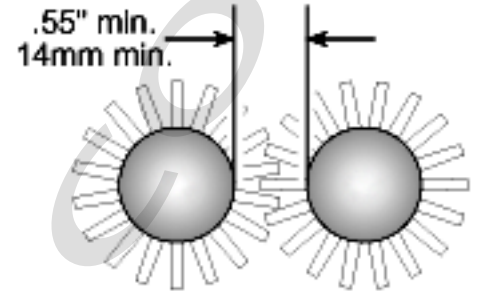

MCF-9: 9-pin Miniature Cooling Performance



MCF-9

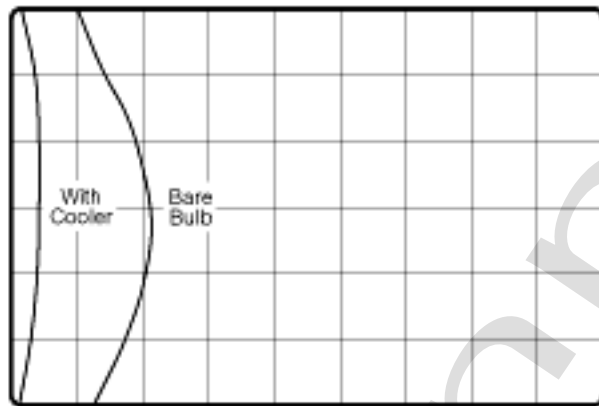

50	75	100	125	150	175	200	225	250	275° C
122	167	212	257	302	347	392	437	482	527° F

Tube Types for this Cooler Model: EF86, 6267, 6F22, M8195, 6AN8, 6DJ8, 6922, 7308, ECC88, E188CC, 6U8, 7199, 7788, E810F, 12AT7, 6060, 6201, 6679, ECC81, E81CC, M8162, ECC801S

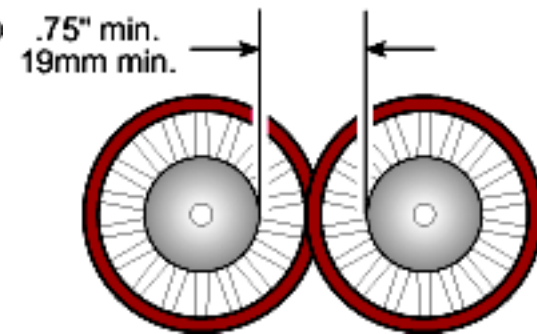
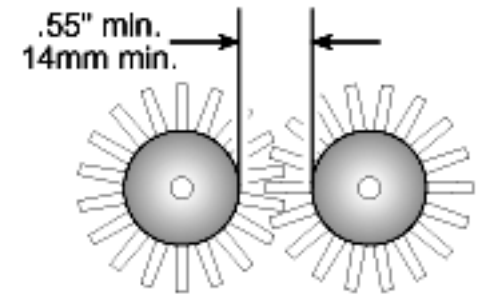

MPCF-9: 9-pin Miniature Power Cooling Performance



MPCF-9

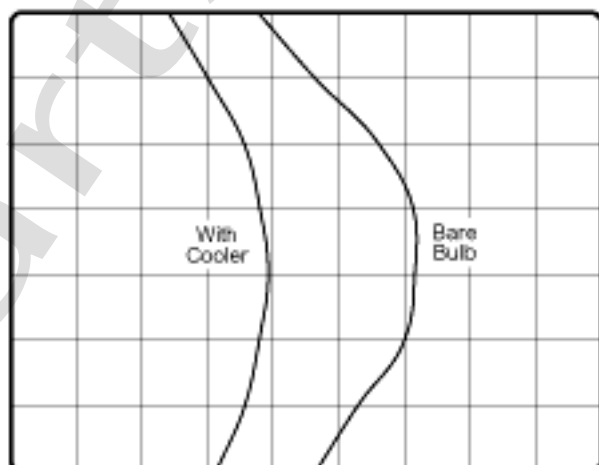

50	75	100	125	150	175	200	225	250	275° C
122	167	212	257	302	347	392	437	482	527° F

Tube Types for this Cooler Model: 6BQ5, EL84, 6CL6, EL86, 6FQ7, 6CL6, 12B4, 12BY7

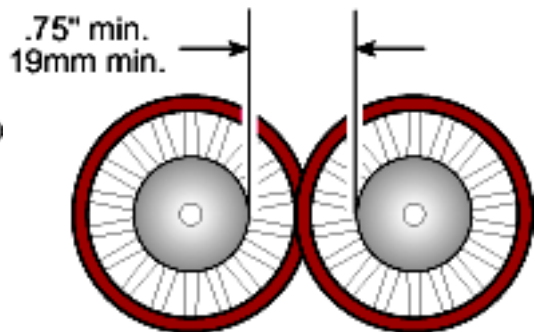
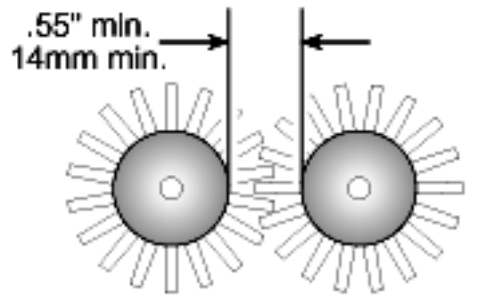

Tube Coolers for Power Tubes. Sizes, Fitted Tubes

PCF-125 Cooling Performance Convection and Fan Cooled

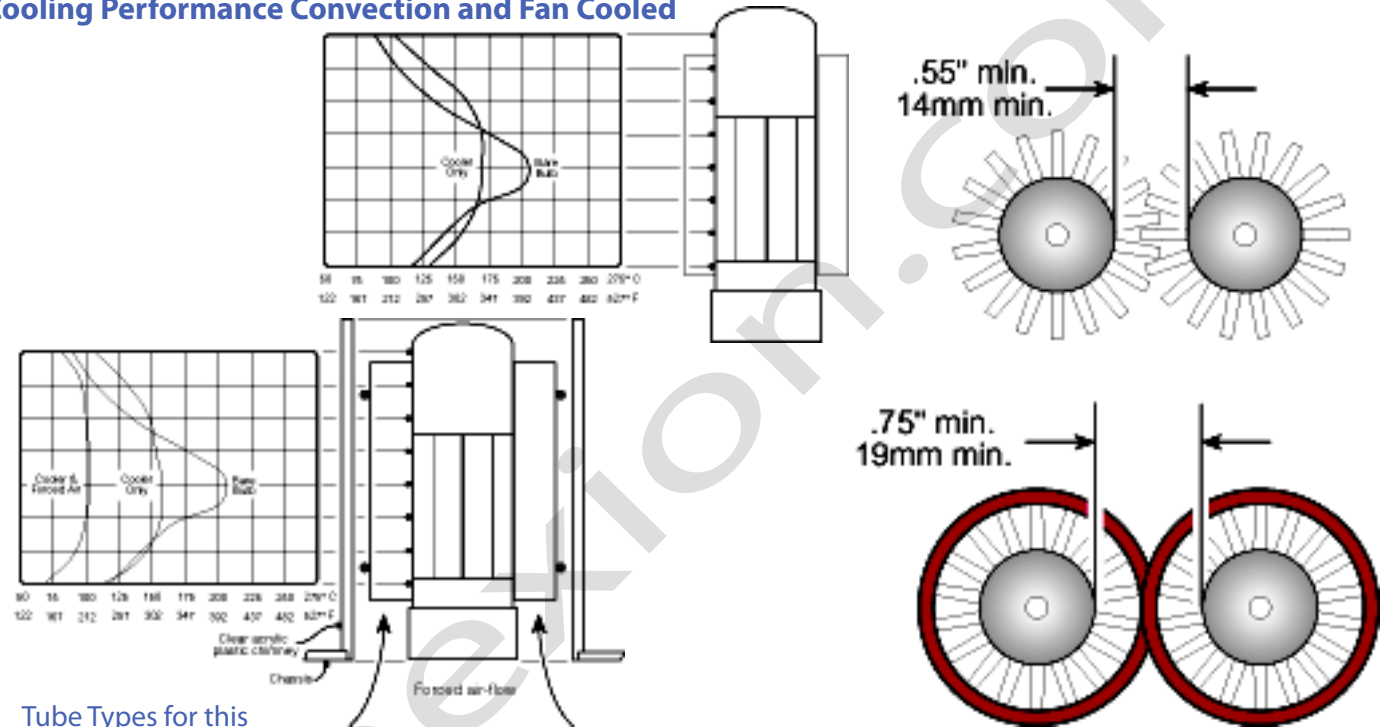

Tube Types for this
Cooler Model: EL34, 6CA7, KT77

PCF-150 Cooling Performance Convection and Fan Cooled

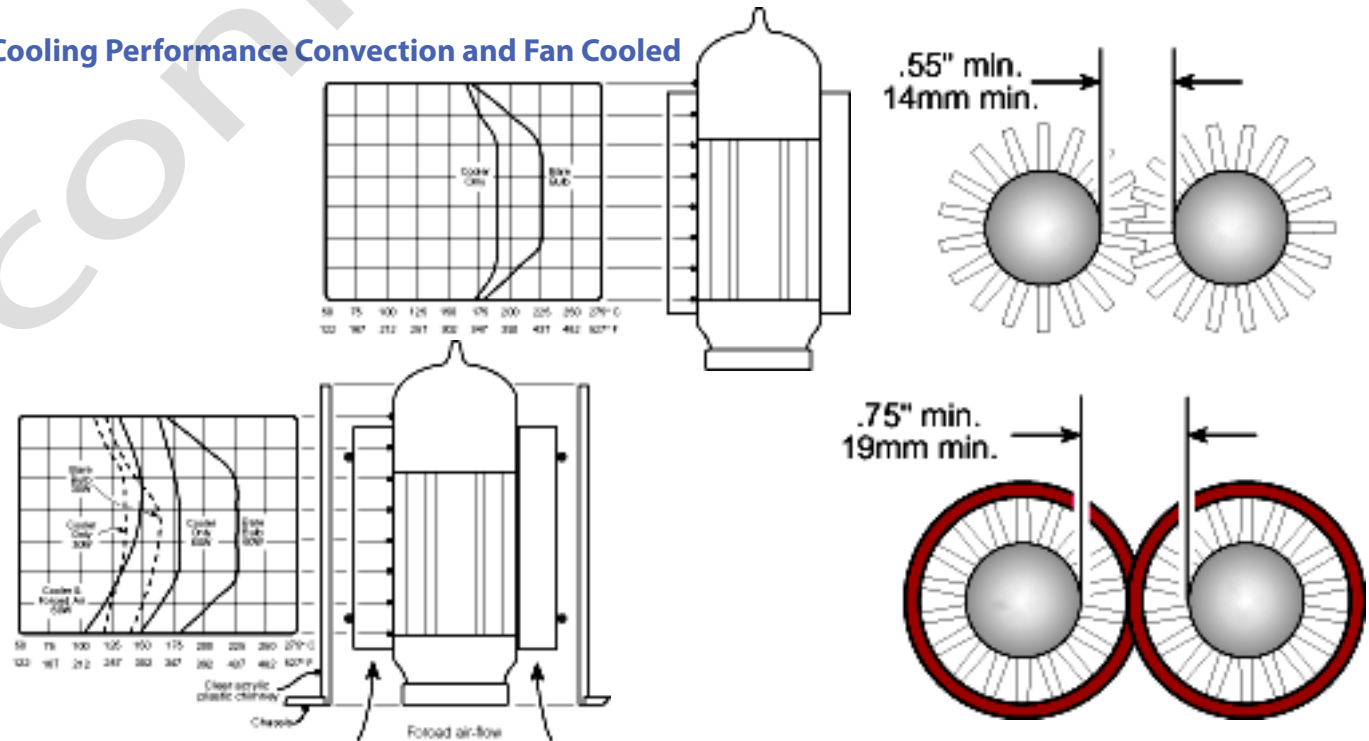

Tube Types for this
Cooler Model: 6550, KT66, 6LF6, 6L6, 5881, EL519, EL509

Tube Coolers for Power Tubes. Sizes, Fitted Tubes



PCF-175

Tube Types for this
Cooler Model: SED - 6550 A/B/C, KT90, KT99, Ei-90A/B/C

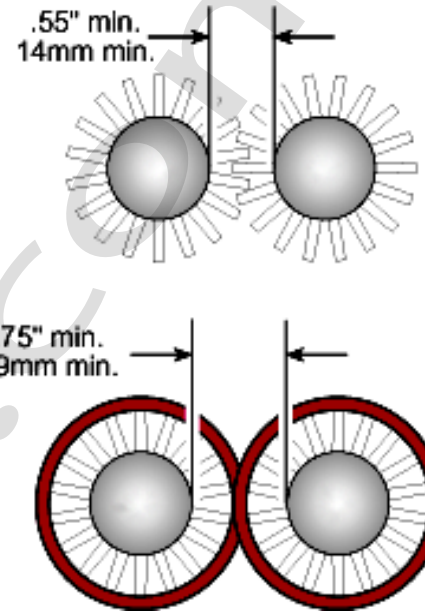

PCF-200 Cooling Performance Convection and Fan Cooled



PCF-200

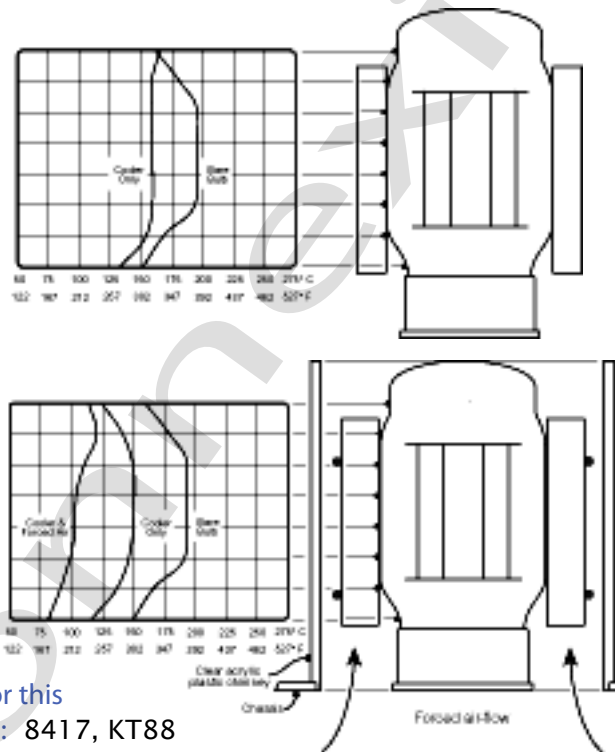

Tube Types for this
Cooler Model: 8417, KT88

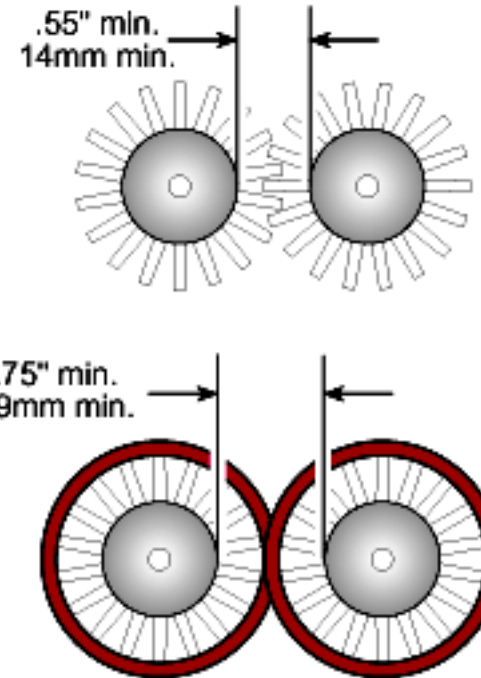

PCF-250

Tube Types for this
Cooler Model: 6C33C-B, 211, 811, 813, 845, 805

