

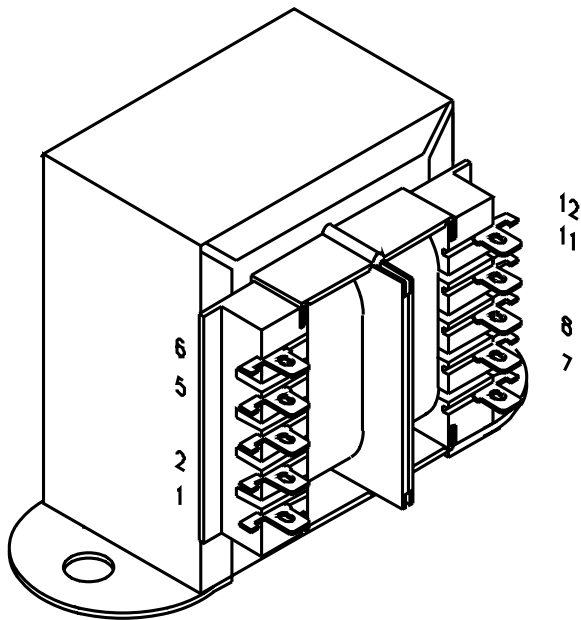

Low Voltage Chassis Mounted Power Transformer



Key Features:

- Universal operation on 50/60Hz, 115/ 230V dual primary for worldwide use.
- Dual bobbin construction
- Dual use terminals (solder lug or quick connect)
- Dual secondaries for series or parallel connections
- 4,000V RMS Hipot tested
- Class F Insulation - 155 degrees C.
- Agency listings: cURus, CE, and TUV.

Overall Dimensions - in. (mm)	
Width	2.81 (71.4)
Depth	2.22 (56.4)
Height	2.31 (58.7)
Weight	1.25 lbs./ 0.6 kg.
Hole to Hole Mounting Dims. - in. (mm)	
Width	2.37 (60.2)
Depth	- (-)
Terminal Lug Data- in. (mm)	
Width	0.19 (4.7)
Thickness	0.02 (0.5)
Electrical	
Size (VA)	25
Primary	115/ 230 VAC
Sec (Series)	12.6V C.T. @2.0A
Sec (Parallel)	6.3V@4.0A

Primary Connections - 185 Series Transformers

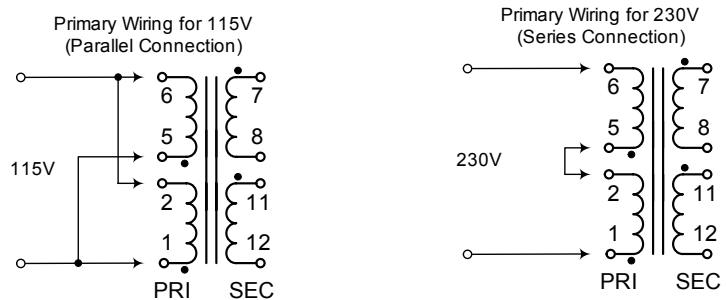

Secondary Connections - 185 Series Transformers

