

Power Transformer - Low Voltage/Filament Dual Primary & Secondary - Open Style Chassis Mount

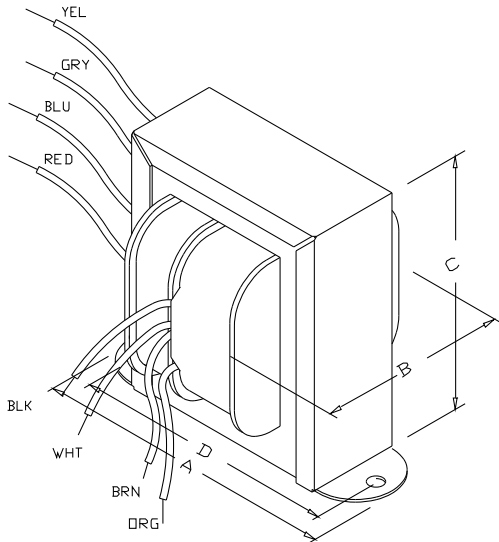

Features

- Primary 117/234 VAC, 50/60 Hz.
- All units have dual secondaries except 266LA25 (C.T. secondary only). If you only require a single primary & secondary check out our more economical 166 Series.
- Secondaries can be used as; a center tapped secondary, parallel connected or used individually (except 266LA25).
- Units are designed for use with all windings engaged.
- Open style.
- Minimum 6" long leads.
- Dual bobbin design - no electrostatic shield required.
- We use Class B insulation (130 degrees, C) for extra protection - UL listed as a Class A (105 degree, C) design
- Hi-Pot test of 2,000V RMS.
- UL listed (# E207860) Type 3AH
- CSA certified (209651)

Overall Dimensions (in / mm)	
A	3.56 / 90
B	2.25 / 57
C	3.12 / 79
D	3.13 / 80
E	3.13 / -
Weight	2.25 lbs / 1.02 kg
Mounting Hole Sizes (in / mm)	
Width-wise	0.187 / 5
Depth-wise	/
Electrical	
Size (VA)	48
Primary	117/234 VAC, 50/60 Hz.
Secondary Series (C.T.)	24V @ 2A
Secondary Parallel	12V @ 4A

Connection Information 266 Series Power Transformers

Primary Connections - 266 Series Transformers

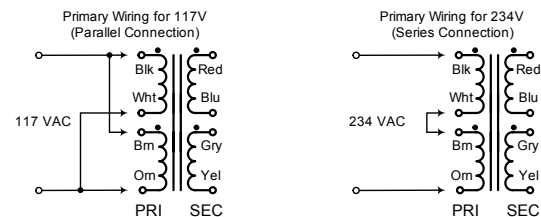

Secondary Connections - 266 Series Transformers

